

SPIDER PLUS

10 J1 HH 41

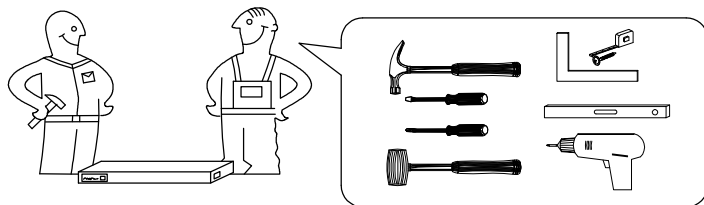

#	ART. NR	L	W	T	Q	Col.No
1	A4515	1800	180	16	1	1
2	A4516	1640	200	22	1	1

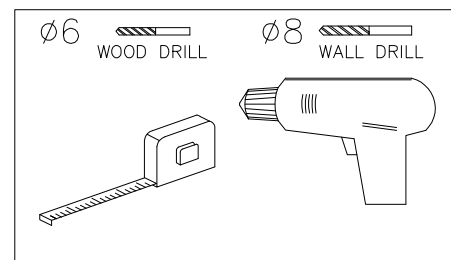
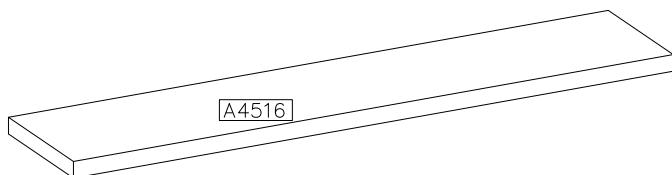
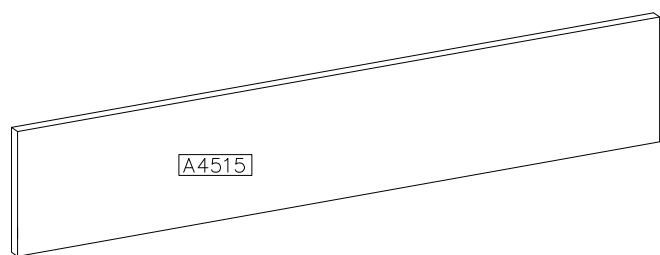
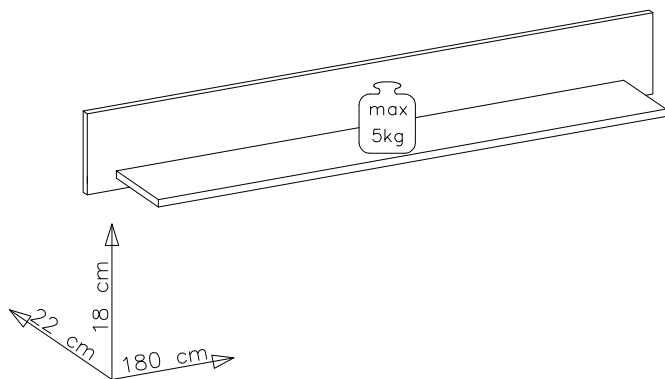
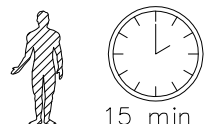
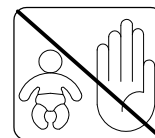
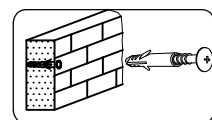
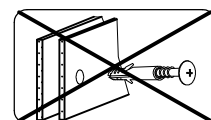
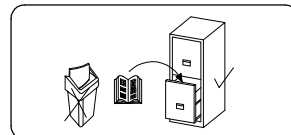
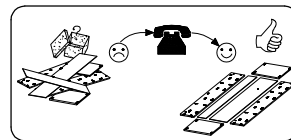
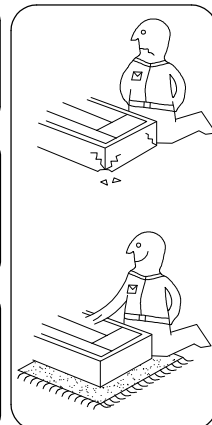
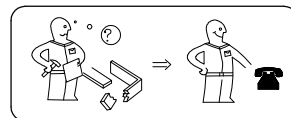

6,3x70mm B1 5	 O 1	 B3 3	5.0x9mm P10 6	ø8.0x50mm Z1 3	ø8.0x50mm Z 1
-------------------------	------------	-------------	-------------------------	--------------------------	-------------------------

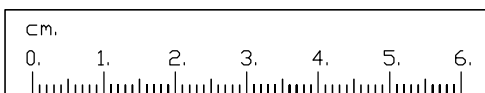

1

6,3x70mm B1 5	 O 1	 B3 3	5.0x9mm P10 6
ø8.0x50mm Z1 3	ø8.0x50mm Z 1		

